

Studying the Effect of Masonry Infill Walls on The Natural Period and Lateral Behavior of RC Buildings in Comparison with the SBC

Abo El-Wafa, W. M., Alsulami, B. T. and Elamary, A. S.

Collage of Engineering, Taif University, Kingdom of Saudi Arabia

Abstract—Although the reinforced concrete frame-infill systems are used throughout the world, they are rarely included in the calculations of the natural period or the numerical analysis of the structures. Masonry infill (MI) walls confined by reinforced concrete (RC) frames play a crucial role, either positive or negative, in altering the lateral capacity of buildings they are applied to. This research paper carries dual targets, the first is studying the effect of the infill walls on the natural period of RC buildings with MI walls. Several configurations of infill walls are studied (considering the wall openings). The interaction between the masonry infill walls and the R.C shear walls in buildings is investigated. Also, this study is intended with investigating the parameters of the equations presented by the Saudi Building Code (SBC) versus other codes to calculate the natural period of shear wall buildings. The second target of this paper is carrying out a nonlinear numerical investigation on the lateral behavior of RC buildings with MI walls. Different configurations of MI walls, size of wall openings, absence of MI walls in the first storey are investigated. The application buildings are either moment resisting frames (MRF) or dual shear wall-moment resisting frames (SW-MRF) buildings. Equivalent strut methodology is used and modified to model the behavior of infill walls taking into consideration the effect of opening sizes. Nonlinear static push-over analysis is carried out for the applied case study buildings.

Keywords: Infill walls - period - lateral response - push-over analysis - wall openings - soft storey - seismic codes.

1 INTRODUCTION

Masonry infill walls are widely used in most existing RC buildings around the world. This wide spread is related to the economical mean they provide to divide and enclose spaces to any required purposes. In regions with seismicity history or even high wind speeds, the lateral loads due to earthquakes or wind loads are the prevailing forces that require, rather than the ordinary gravity loads, special attention in assessing the behavior of such buildings. The structural contribution of masonry infill walls to the buildings they are implemented in is seldom included in the analysis and design of such structures [1] - [3]. This ignorance occurs although many experiments on RC frame buildings confining masonry infill walls show that infill walls have a high initial lateral stiffness and low deformability. The contribution of masonry infills may change the lateral load transfer mechanism of the structure from predominant frame actions to predominant truss actions. [1], [4]. The reality that the infill walls have significant contribution to the lateral performance of RC structures, either in a positive or negative way, and can highly alter the structural response of buildings was highly supported and illustrated by the performance of buildings in the recent earthquakes (e.g., 1985 Mexico City, 2001 Bhuj (India) and 1999 Kocaeli (Turkey) earthquakes) [5] , [6]. The fundamental period is an important design parameter that plays a significant role in the computation of design base shear. The design codes provide approximate empirical expressions to estimate the fundamental period. Although the use of more accurate methods of mechanics is permitted in the codes. It is specified that the value of natural period obtained by such methods must not be overestimated as this tends to underestimate the seismic forces. In the begin-

ning of the seismic excitation the undamaged structure will have much higher stiffness than the considered (i.e. accepted in the model) one. This means, that the structure should withstand loading that is several times larger than the design loading to which it has been dimensioned. The overestimation of natural period may mainly be related to uncertainties associated with the participation of nonstructural elements whose effects may not have been considered in period determination and on the seismic response [7], [8].

The periods of some actual concrete buildings were recorded during past earthquakes in many places in the world and compared to the code equations, distinct difference between the results was reported [7], [9]. Moreover, a recently conducted field study revealed that buildings are often much stiffer than that predicted by the computer analysis of the skeletal frame due to the participation of infill brick walls [10]. Experimentally, the influence of the “non-structural” elements was established in an illustrative way during an in-situ test of two eight-storey buildings. While the first building is completed, only the main structure of the second one is completed, for the first building (the stiffness is resulted from the interaction between the main structural system and the masonry infills) the fundamental period was 0.60 s. This value was recorded as 0.95 s for the second building (the stiffness is obtained only by the main structural system).

Most semi-empirical building codes use a building period directly proportion to the magnitude of the force that should be sustained by buildings at a specific stress level and provide empirical formulas to determine the lower bound fundamental period in order to establish the proper design force level.

However, such codes have not settled on a uniform method for determining the period, because the required design force level and characteristics of buildings constructed in each region are different.

To deal with the subject of MI walls, various national codes can be broadly grouped in two categories of those that consider or do not consider the role of MI walls while designing RC frames. A very few codes specifically recommend isolating the MI walls from the RC frames such that the stiffness of MI does not play any role in the overall stiffness of the frame. As a result, MI walls are not considered in the analysis and design procedure. The isolation helps to prevent the problems associated with the brittle behavior and asymmetric placement of MI walls. Another group of national codes prefer to take advantage of certain characteristics of MI walls such as high initial lateral stiffness, cost-effectiveness, and ease in construction. These codes require that the beneficial effects of MI walls are appropriately included in the analysis and design procedure and that the detrimental effects are mitigated. In other words, these codes tend to maximize the role of MI walls as a first line of defense against seismic actions, and to minimize their potential detrimental effects through proper selection of their layout and quality control [11]. The Saudi Building Code [12], [13] presented some general provisions related to the MI walls (called in this code Non-structural elements NSE). No provisions related to modeling of MI walls, effect of openings or soft stories are presented in this newly edited code.

The subject of masonry infilled reinforced concrete frames had attracted many researchers over the past five decades. Their efforts have been paid in many areas related to this subject such as modeling and idealization of infill walls [14], [15], experimental investigations [16], [17], modeling infill openings as windows and doors [5], natural period of infilled frames [18], [19] and numerical investigations [20]-[23]. Despite the relatively large number of seismic reliability studies in the literature, few deal with infilled frames and there is still a lack in the knowledge of many aspects concerning this concept. Among the research needs identified were (1) The effect of the MI walls on the natural period of structures. (2) the influence and interaction of some MI parameters (i.e., wall configuration, opening size, wall thickness and existence of soft stories); (3) the interaction between MI and RC shear walls. This paper is intended to fulfill these mentioned needs.

2 CASE OF STUDY BUILDING

The first studied building is a typical moment resisting frame (MRF) reinforced concrete administrative building without shear walls. The dimensions of the building are 25.0 by 18.0 m. The typical bay width is 5.0 m in the longitudinal direction and 6 m in the transverse direction, a plan of the building is shown in Fig. 1. The building has six floors with height from the ground of 19.5 m, the typical floor height is 3.0 m except the first floor which has a height of 4.5 m, no basement is presented. The gravity load resisting system consists of 0.12 m thickness two way solid slab supported by beams of 0.2 m width and overall depth of 0.6 m, the beams are modeled with real reinforcement as specified by the design. The loads of each floor are transmitted to the columns which are

modeled with different plan dimensions and reinforcement according to the design of building, the dimensions and reinforcement of the columns vary with height. The lateral load resisting system is the frame action between beams and columns, the dimensions of the columns in the first storey are shown in Table 1. The compressive strength of concrete used for the building is 25.0 MPa while the used steel is high tensile with yield strength of 420 MPa.

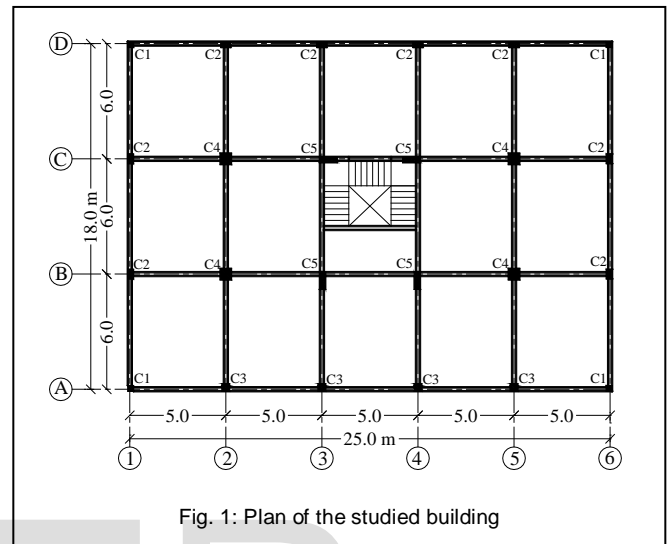

Fig. 1: Plan of the studied building

Table 1: Dimensions of columns (m) in the first floor.

Model	C1	C2	C3	C4	C5
Dim.	0.30 x 0.30	0.30 x 0.50	0.40 x 0.40	0.60 x 0.60	0.30 x 0.90

In this analysis, the infill walls function mainly as building cladding positioned at all four sides of building plus, in some specified configurations, internal partitions in some considered places. The different configurations of infill walls, considered in this study, mainly depend on two parameters. The first parameter is the number of cladding sides at which openings can be applied due to the site conditions, whether this side faces a street or adjacent to another building. The openings are applied to the considered external cladding walls only according to the configuration while all the internal walls are solid. The openings are applied with almost large size, each opening occupies about 18.5 % of the wall at which it is applied. The second considered parameter of wall infills is the existence of internal walls. In this study the internal walls are applied only at some selected places, these internal walls are used as partitions without any openings. Relying on those two parameters, eight different configurations are considered to determine the effect of possible infill walls applications on the structural response. A plan of the different eight configurations of masonry infill walls used in this study along with the specified notation for each configuration are illustrated in Fig. 2.

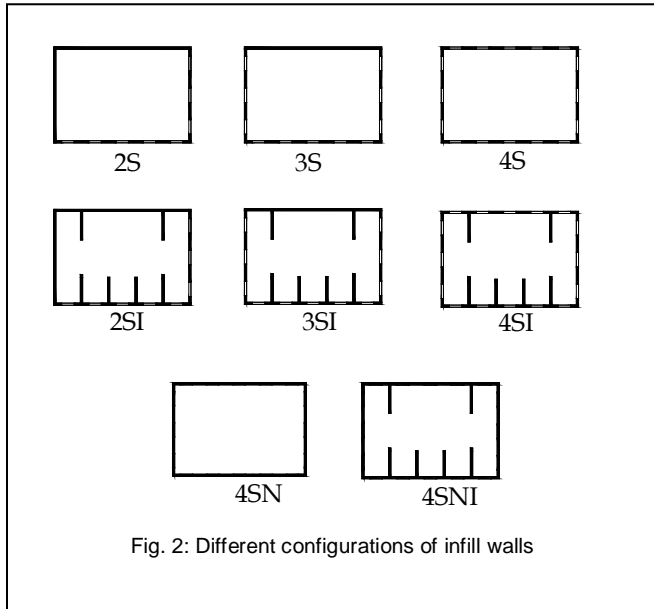

Fig. 2: Different configurations of infill walls

The notations presented in Fig. 2 can be described as:

2S: Only 2 walls of the four external walls have openings, no internal walls.

3S: Three walls of the external walls have openings, no internal walls.

4S: All the four external walls have openings, no internal walls.

4SN: None of the external walls has openings, no internal walls.

2SI, 3SI, 4SI and 4SNI: The same external wall configurations as 2S, 3S, 4S and 4SN, respectively, but with the consideration of internal walls.

3 IDEALIZATION OF INFILL WALLS AS DIAGONAL STRUT

Investigations to model the behavior of masonry infill walls, experimentally and analytically, have been conducted over the past decades. Different types of analytical macro-models, based on the physical understanding of the overall behavior of an infill panel, were developed to model the behavior of infilled frames. The single strut model is the most widely used of the available models, though this model is the simplest one, it is unable to capture the local effects occurring to the frame members, but, it is evidently the most suitable one for analysis of large structures. Thus, R. C frames with unreinforced masonry walls are modeled as equivalent braced frames (EBF) with infill walls replaced by "equivalent struts". The early versions of this equivalent strut model included a pin-jointed strut with its width taken as one-third the infill diagonal. Using the theory of beam on elastic foundation, a non-dimensional parameter was defined as the relative lateral stiffness of the infill. This method was further extended to predict the lateral stiffness and strength of multi-storey infilled frames [1]. Another model for representing the brick infill panel by equivalent diagonal strut was proposed by Mainstone [15] and widely used by many researchers. For this

model, the strut area, A_e , was given by the following expression:

$$A_e = w_e t$$

$$w_e = 0.175(\lambda H)^{-0.4} \sqrt{(H^2 + L^2)}$$

$$\lambda = \sqrt[4]{\frac{E_i t \sin(2\theta)}{4E_c I_c H_i}}$$

H and L are the height and length of the frame, respectively, E_c and E_i are the elastic moduli of the column and of the infill panel, respectively, t is the thickness of the infill panel, θ is the angle defining diagonal strut, I_c is the moment of inertia of the column and H_i is the height of the infill panel.

Although infill walls usually have oversized openings, recent research has focused mainly on the simple case of infill walls without openings, research of the infill wall with openings is still limited. Recently, Asteris [5] investigated the influence of the masonry infill panel opening in the reduction of the infilled frames stiffness by means of finite element technique. The values of the stiffness reduction factor relying on the percentage opening and the position of opening are presented in the form of diagrams. His study found that the effect of openings can be estimated by multiplying the value of w_e in Eq. (2) of Mainstone [15] by the value of the reduction factor represented by Asteris [5]. A schematic diagram of modeling infill walls as equivalent strut is shown in Fig. 3.

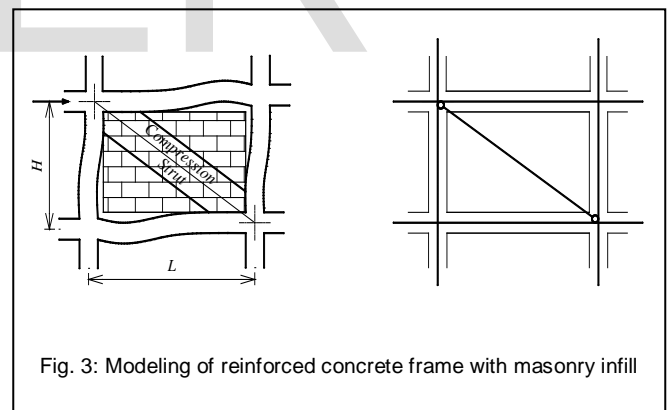

Fig. 3: Modeling of reinforced concrete frame with masonry infill

4 EFFECT OF INFILL WALLS ON THE NATURAL PERIOD

The 3-D modal analysis of the studied MRF building with different prescribed eight cases of infill wall configurations is carried out. The modal analysis is carried out over masonry infill wall stiffness ranges between 2.0 MPa and 8.0 MPa. The obtained results of the fundamental natural period are compared with those obtained from the SBC equations ($T=0.1 N$, where N is the number of stories or $T=C_t h^x$ in which h is the total building height, C and x are parameters depends on the structural type of the building).

The effect of considering the masonry infill walls on the values of natural period can be observed clearly from Figs. 4 and 5. It is found that excluding the effect of these walls from

the modal analysis can lead to highly overestimated natural period values. In comparison with code equations, the bare frame results in natural period values about twice the value suggested by the SBC. This high overestimation can lead to high reduction in the seismic forces the structure is supposed to be designed to resist, and hence unsafe seismic design. The great problem of high variation between the natural vibration results obtained from modal analysis software, when ignoring the effect of infill walls, and the values suggested by the code equations almost faces researchers and designers. This high variation can be highly reduced by considering the effect of infill walls in the modal analysis. The reduction in the values of natural vibration of the building, considering the effect of infills, relative to the bare frame ranges between 25% and 67%. Although there is a wide range of wall stiffness considered in this study, the results of natural period for all studied eight cases with infill walls are scattered around the suggested values of the equations suggested by the SBC. For all the studied cases, the maximum upper difference related to this code does not exceed 49.5% while the maximum lower difference related to the same codes does not exceed 41%. The excess in the values of the maximum lower differences are resulted from the cases when ignoring the openings of the external walls. Frames with infill walls having stiffness ranges between 4.0 and 6.0 MPa, result in values of natural period with maximum difference related to the code does not exceed 31%, the maximum lower difference is about 35%.

The effect of changing the types of brick infills through changing their stiffness on the obtained results of fundamental period is studied. It is clear that the values of the fundamental period are reversely proportional to the masonry infill wall stiffness. The effect of stiffness on the obtained values of natural period is more remarkable with small stiffness values and decreases as the wall stiffness increases. The stiffness of the infill walls has almost the same effect on the different studied configurations. The difference between the maximum and minimum fundamental period, for each configuration, relative to that of the bare frame ranged between about 15.6 % and 21.0 %.

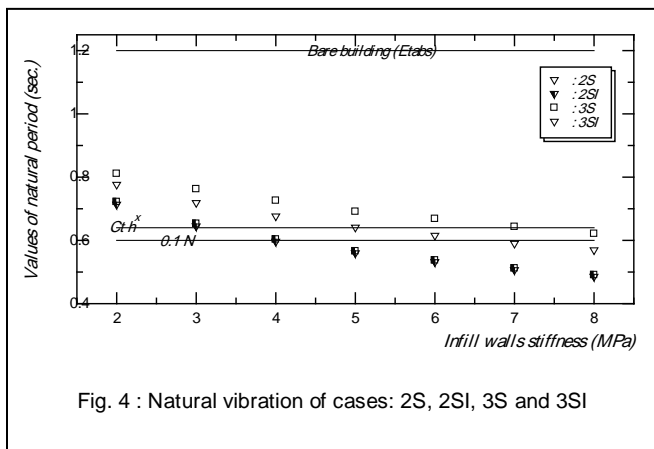

Fig. 4 : Natural vibration of cases: 2S, 2SI, 3S and 3SI

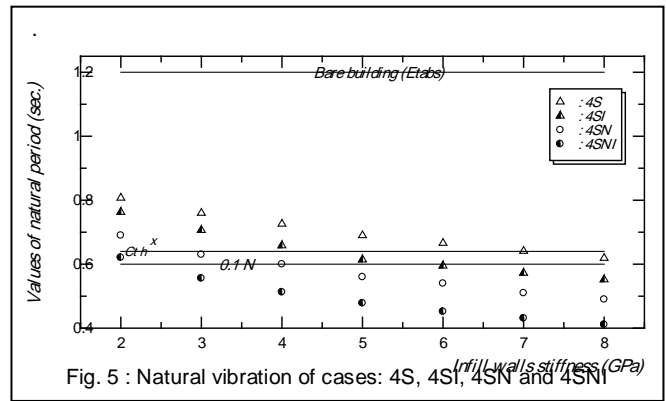

Fig. 5 : Natural vibration of cases: 4S, 4SI, 4SN and 4SNI

5 MODAL ANALYSIS AND COMPARISON WITH SBC

The effect of the interaction between RC shear walls and MI walls on the natural period of shear wall-moment resisting buildings (SW-MRF) is investigated. The case of study building described in Figs. 1 and 2 is modified and redesigned to have 5 different heights (6, 9, 12, 16 and 20 floors). The lateral resisting system of all buildings consists of shear walls plus moment resisting frames. The thickness of all shear walls are kept constant and equal 0.20 m. The effective total lengths of shear walls in the first floor in each orthogonal direction (L_w) is designed to meet the seismic requirements and is taken as a ratio of the total height of building (H). This ratio (L_w / H) is 0.20 for walls along the short direction and 0.165 for walls situated in the longitudinal direction. The position of shear walls for building with different heights represented by the number of floors are shown in Fig. 6. For brevity, only the results of case 2S configurations are presented.

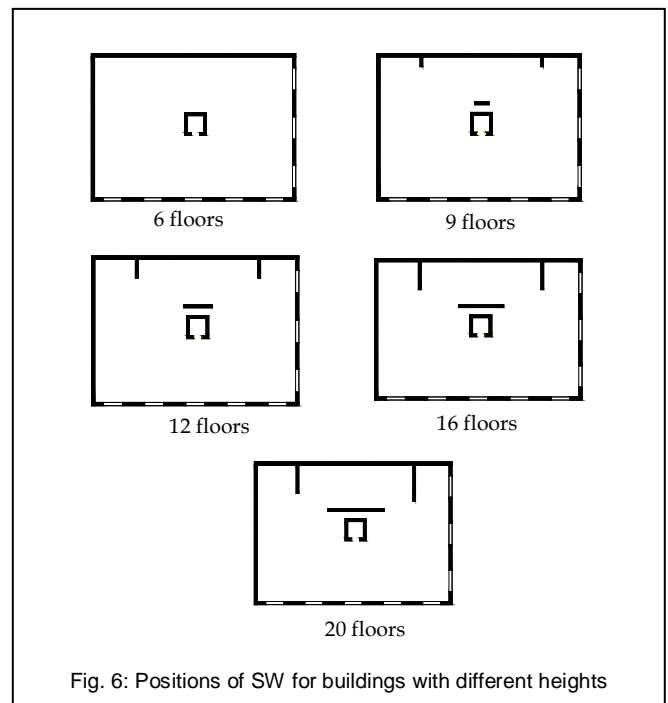

Fig. 6: Positions of SW for buildings with different heights

The influence of the effective total lengths of shear walls relative to the height of building (L_w/H) on the obtained period using the equations presented by the UBC 97 and SBC for buildings with RC shear walls is investigated. The equations are shown in the appendix. This is carried out in comparison with the corresponding values of modal analysis, applying two shear walls in the considered direction. The obtained results are shown in Fig. 7. In this figure the values obtained from the SBC and UBC 97 are represented using thick continuous and dashed lines, respectively, while the results obtained from the modal analysis are given symbols.

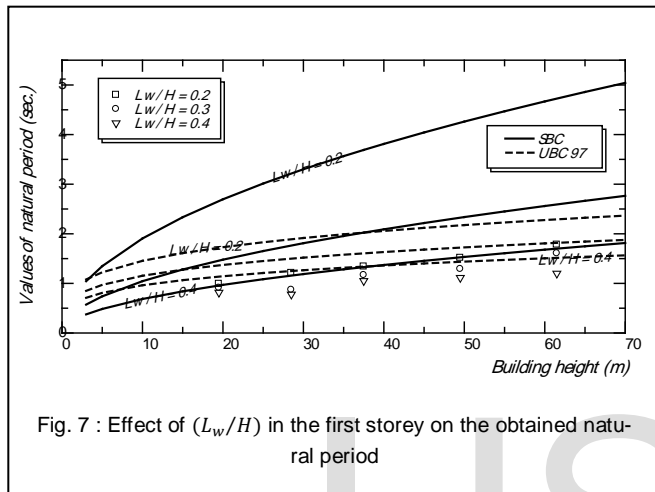

Fig. 7 : Effect of (L_w/H) in the first storey on the obtained natural period

It is found that all the values suggested by the investigated two codes equations are, in contrary to the usual trend, higher than the values obtained from the modal analysis of the studied buildings, although ignoring the effect of infills. According to the SBC, buildings with (L_w/H) equal 0.2 yields extremely high values of natural period, ranges from about 1.75 to 7.5 times the values suggested by the same code for the same building without shear walls. Very high values of fundamental period still also be obtained using either of the studied codes at (L_w/H) ratio of 0.3 and 0.40. It can be noted that there is high difference in the values of natural period obtained using the two studied codes. This variation in the results decreases as the (L_w/H) ratio increases. The variation in the results obtained from the modal analysis for the same ratios of wall lengths to height ratios using ETABS software [24] are much less than those obtained from the studied codes equations, especially those obtained using the SBC. The variation in the values decreases as the (L_w/H) ratio increases.

6 LATERAL RESPONSE OF RC BUILDINGS WITH MI

The nonlinear push-over analysis of the 6 floor buildings with either lateral load resisting systems, moment resisting frame (MRF) and dual shear wall-frame system (SW-MRF), is carried out to assess the effect of the considered infill parameters. The case of study 6 floors building shown in Fig. 2 is modified and redesigned to consider the interaction between RC and MI walls. The modified building is shown in Fig. 8. The following notations are used:

OBF: The original bare frame without MI walls.

R33, R44 and R66: The number of bays occupied with MI to total bay numbers in the lateral direction (N_i / N_t) is equal to 33.33 %, 44.44 % and 66.67 %, respectively.

R44-20, R44-40 and R44-60: Buildings with (N_i / N_t) equal to 44.44 %, the MI walls have openings result in stiffness reduction factor λ of 20%, 40% and 60%, respectively.

R33-40S, R44-40S and R66-40S: Soft first storey buildings having MI walls with openings yield λ of 40 %, (N_i / N_t) equal 33.33 %, 44.44 % and 66.67 %, respectively.

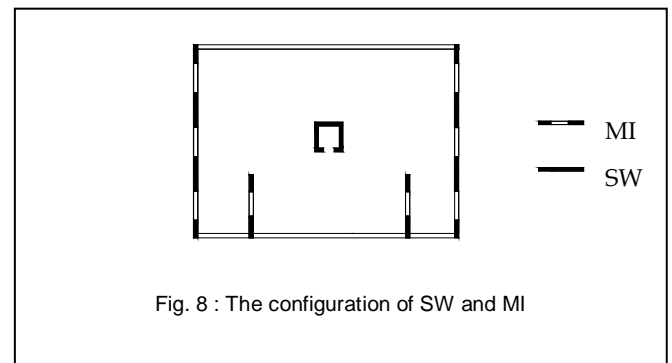

Fig. 8 : The configuration of SW and MI

The effect of different MI solid walls, without openings, configurations represented by (N_i / N_t) values equal 33.33 %, 44.44 % and 66.67 % is studied. The nonlinear push-over analysis curves for both MRF and SW-MRF buildings are shown in Figs. 9 and 10. It can be observed that comparing the nonlinear behavior of the OBF buildings with the normalized (V/W) design values obtained from the Saudi Building Code leads to that the first yield (V/W) value of the OBF is about 2.06 times the code design value for the MRF while it is about 1.59 for the SW-MRF buildings. Existence of RC shear walls influences an increase in the slope of the push-over curve for SW-MRF building in comparison with the MRF building which exhibits push-over curve with almost horizontal slope. This behavior results in at failure (V/W) value about 3.8 times the design one for MRF building, while it is about 4.06 for SW-MRF building.

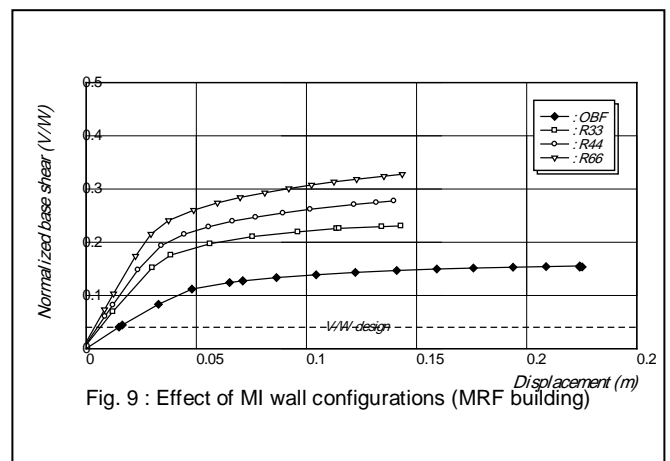

Fig. 9 : Effect of MI wall configurations (MRF building)

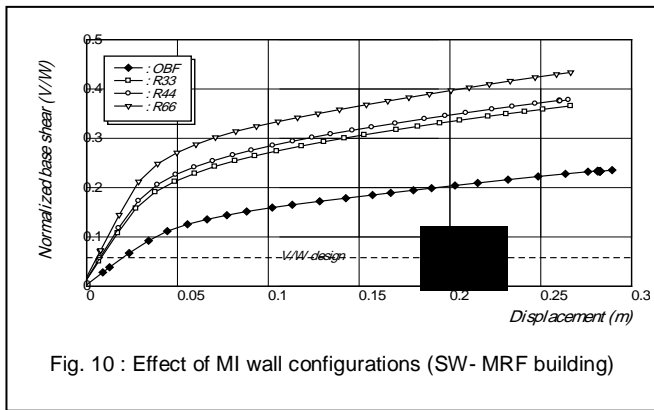

Fig. 10 : Effect of MI wall configurations (SW- MRF building)

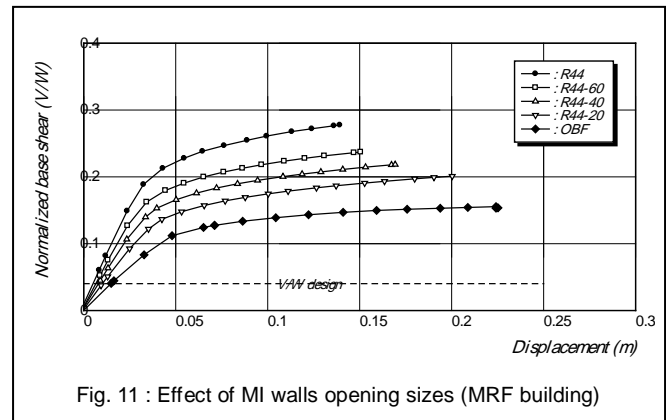

Fig. 11 : Effect of MI walls opening sizes (MRF building)

The MI walls have a pronounced effect on the lateral response of the studied frames. Generally, the presence of MI walls increases the stiffness of the building, represented by (V/W), relying on the infill configuration and type of building. MI walls applied to MRF building could increase the maximum normalized base shear relative to the values of the corresponding OBF with ratios equal to 113.23 %, 80.25 % and 50.12 % for different (N_i / N_t) values equal 66.67 %, 44.44 % and 33.33 %, respectively. Similar trends could be observed for SW-MRF buildings but with percentage increase of 84.11 %, 60.55 % and 55.28 % for the same preceded configurations, respectively.

In contrary to the gain in the stiffness associated with the consideration of MI walls, there is a notable reduction in the ductility, relative to OBF for MRF building. The accounted reduction in peak nonlinear displacement relative to the corresponding value of OBF is not less than 35.5 % and almost independent of the configurations. This high reduction in lateral displacement could negatively alter the lateral response of building by shifting the building performance points or may lead to the incapability of the building to meet appropriate performance point when subjected to high lateral loads. It is evident from the shown figures that the existence of shear walls could highly control the reduction of ductility expected to the masonry infilled SW-MRF building, the reduction in maximum displacement capacity of these cases relative to the same OBF building does not exceed 7.91 %. For these SW-MRF buildings, the peak displacement capacity is so close for the different studied configurations.

As it is practical to have openings in the MI walls with different sizes, the lateral response of the case study buildings with openings having different sizes is analyzed. For brevity, only the results of configuration R44 with different opening sizes are displayed in comparison with the same configuration with solid MI walls as shown in Figs. 11 and 12. It is clear that the existence and size of openings have an importance on both strength and ductility of masonry infilled MRF buildings. The peak building displacement capacity increases as the opening size increases. The percentage increase relative to the same configuration without openings are 7.75 %, 21.62 % and 43.68 % for opening sizes corresponding to stiffness reduction factors of 60 %, 40 % and 20 %, respectively.

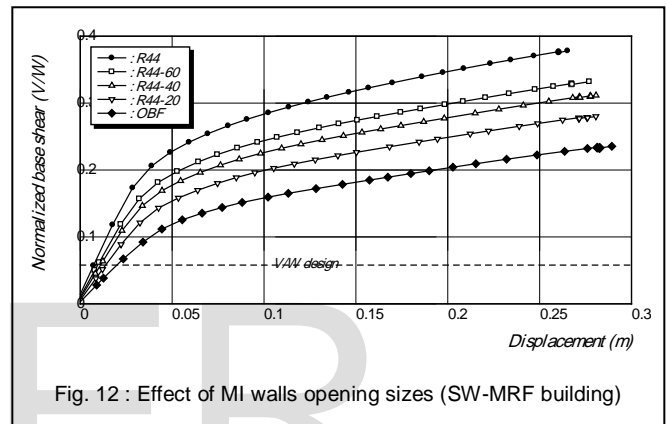

Fig. 12 : Effect of MI walls opening sizes (SW-MRF building)

On the contrary, for SW-MRF buildings, the opening size has minor effect on the building displacement capacity. The percentage increase in peak building displacement capacity for buildings with different opening sizes relative to corresponding configuration with solid MI does not exceed 5.85 %. Related to the maximum normalized base shear, it is found that the influence of opening sizes is close for both building types, MRF and SW-MRF, and is inversely proportional to the opening size. The percentage reduction in the stiffness, related to same configuration with solid MI walls ranges between 14.6 % and 27.6 % for MRF building while this ratio ranges between 12.17 % and 27.6 % for SW-MRF building.

The influence of the absence of MI walls in the first storey, which is commonly used in residential and commercial buildings, forming what is called (first soft storey) is studied. The results of different configurations with (N_i / N_t) equal to 33.33 %, 44.44 % and 66.67 % having opening size generates a stiffness reduction factor of 40 % for the two considered building types are shown in Figs. 13 and 14. It can be found that the absence of walls in the first storey while applying them in the rest of stories, can negatively alter the lateral response of MRF buildings. Compared to the reference OBF case, MI walls could increase the peak shear wall capacity of the mentioned MRF building by values range between 2.67 % and 16.90 % for the different configurations, arranged from R33-40S to R66-40S, respectively. This minor increase in the building normalized base shear capacity is associated with a drastic reduction in the nonlinear displacement capacity and hence building

ductility. The reduction in nonlinear displacement relative to the reference OBF sample case ranges between 39.47 % to 49.55% for cases R33-40S and R66-40S, respectively. For more illustration, a comparison could be made also between sample cases with and without regular infills as cases R44-40 and R44-40S, for example. This comparison results in that there is a reduction in both maximum normalized base shear and nonlinear peak displacement of 21.6 % and 24.0 %, respectively due to the absence of MI walls in the first storey.

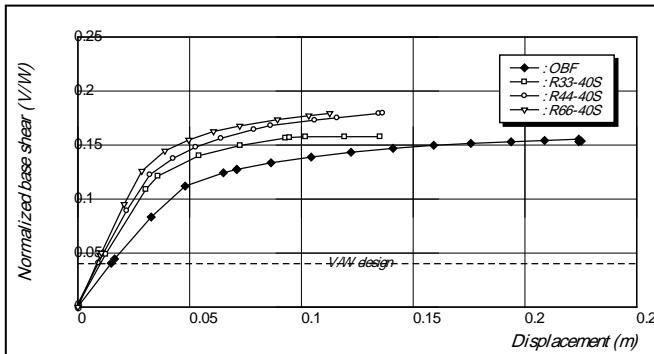

Fig. 13 : Effect of absence of MI walls in the first storey (MRF building)

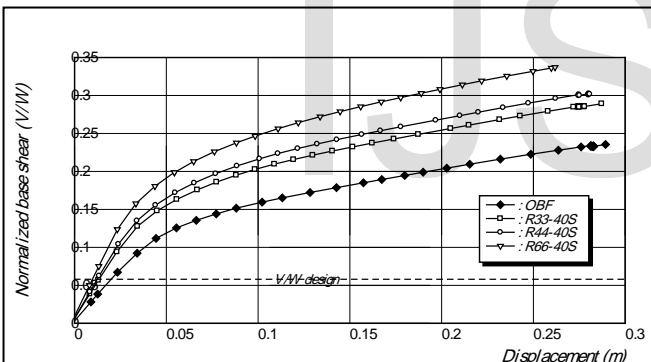

Fig. 14 : Effect of absence of MI walls in the first storey (SW-MRF building)

Discussing the results of the preceded sample cases but for SW-MRF buildings yields that, again, it is clear that the existence of uniform RC shear walls has a great influence in controlling the nonlinear displacement capacity when applying irregular MI walls lead to first soft storey. The maximum reduction in the nonlinear displacement associated with any of the masonry infilled building cases relative to the reference OBF building does not exceed 9.5 %. Carrying out a comparison between two cases of building type SW-MRF with regular and irregular infill walls as cases R44-40 and R44-40S, it is found that the values of nonlinear displacement is almost the same while the percentage reduction in normalized base share does not exceed 3.5 %.

7 CONCLUSIONS

Relying on the investigations and discussions presented in this study, the following conclusions may be drawn out.

- 1) Ignoring the effect of masonry infill walls from the modal analysis of moment resisting reinforced concrete frame buildings results in very high overestimation of the fundamental period in comparison to the values obtained from the SBC equations. This high overestimation will, in turn highly reduce the seismic forces the building should be designed to resist. Considering the effect of infills, especially with medium stiffness, in the modal analysis yields values of fundamental period very close to those suggested by the SBC.
- 2) Using the period equations specified for shear wall building in the SBC to determine the period of shear wall buildings yields extreme variation in the results due to changing the (L_w/H) ratio. The results obtained from the SBC are completely different from the corresponding UBC 97 equations or the results obtained from the modal analysis using ETABS software even with bare frame.
- 3) The influence of MI walls on the lateral response of buildings should not be simply neglected. MI walls can significantly change the lateral response of RC framed buildings to which they are applied. Solid MI walls regularly distributed over the building height can highly increase the peak base shear capacity to values up to 113.0 % and 84.0 % for MRF, and SW - MRF buildings, respectively.
- 4) Although MI walls have relatively similar contribution to lateral stiffness of either MRF or SW-MRF buildings, its influence on peak nonlinear displacement capacity is significantly affected by the type of building. While they can drastically reduce the displacement capacity of MRF buildings to values up to 50.0 %, the existence of uniform RC shear walls can highly restrict the reduction of peak displacement capacity to less than 8.0 %.
- 5) The most influential MI wall parameter is where a soft first storey is generated in MRF buildings due to omitting the MI walls from the first storey while applying them to the rest of stories. While a tiny gain could be achieved in stiffness, a drastic reduction could occur to displacement capacity. For an example case, an increase in base shear capacity of less than 3.0 % was associated by a reduction in peak displacement capacity of about 40.0 %.
- 6) The effect of masonry wall configurations represented by the number of bays occupied with MI to total bay numbers in the lateral direction (N_i / N_t) along with the opening size were the second important parameters affecting infilled frames. These two parameters could significantly alter the building capacity for both MRF and SW-MRF buildings and negatively affect the ductility of MRF buildings.
- 7) The new edition of the SBC renewed some general provisions related to the matter of MI walls. Detailed provisions need to be included about some MI wall aspects as modeling methodology, effect of infill parameters as soft first storey and openings in infill walls.

APPENDIX

The approximate fundamental period, T_a , in seconds for masonry or concrete shear wall structures in the SBC shall be permitted to be determined as follows:

$$T_a = \frac{0.0062}{\sqrt{C_w}} h_n$$

where h_n is the height of the building and C_w , is calculated as

$$C_w = \frac{100}{A_B} \sum_{i=1}^n \left(\frac{h_n}{h_i} \right)^2 \left[\frac{A_i}{1 + 0.83 \left(\frac{h_i}{D_i} \right)} \right]$$

In The UBC 97 code, The value of T_a , for for structures with concrete or masonry shear walls may be taken as:

$$T_a = C_t h_n^{3/4}$$

$$C_t = 0.075 / \sqrt{A_c}$$

$$A_c = \sum A_i (0.2 + (D_i / h_n)^2)$$

Where:

A_B = the base area of the structure m^2

A_i = the area of shear wall "i" in m^2

D_i = the length of shear wall "i" in m

ACKNOWLEDGMENT

This study is supported by Taif University under a (Grant No. 1-435-3514). The university is highly acknowledged for its financial support.

REFERENCES

- [1] Kormaz, K.A., Demir, F., Sivri, M.: " Earthquake Assessment of R/C Structures with Masonry Infill Walls " International Journal of Science & Technology, Volume 2, No. 2, pp. 155-164, 2007.
- [2] Flanagan, R.D., Bennett, R.M.: " In-plane Behavior of Structural Clay tile Infilled Frames " Journal of Structural Engineering, Vol. 125, No. 6, pp. 590-599, 1999.
- [3] Chiou, Y., Tzeng, J., Tzeng, Y.: " Experimental and Analytical Study of Masonary Infilled Frames " , Journal of Structural Engineering, Vol. 125, No. 10, pp. 1109-1117, 1999.
- [4] Dymiotis, C., Kappos, A., Chryssanthopoulos, K.: " Seismic Reliability of Masonry - Infilled RC Structures " Journal of Structural Engineering, Vol. 127, No. 3, pp. 296-305, 2001.
- [5] Asteris, P.G.: " Lateral Stiffness of Brick Masonry Infilled Plane Frames " Journal of Structural Engineering, Vol. 129, No. 8, pp. 1071-1079, 2003.
- [6] Berman, J.W., Celik, O.C., Bruneau, M.: " Comparing Hysteretic Behavior of Light-Gauge Steel Plate Shear Walls and Braced Frames " Journal of Structural Engineering, Vol. 125, No. 6, pp. 578-589. 1999.

- [7] Tinawi, R.: " An Overview of Fifty Years of Development for the Canadian Seismic Building Code " EGYQUAKE 3, Third Egyptian Conference on Earthquake Engineering, Cairo, 2004.
- [8] Saatcioglu, M., Humar, J.: " Dynmic Analysis of Buildings for Earthquake Resistant Design " Research Press Web site at <http://cjce.nrc.ca> on 23 April 2003.
- [9] " NEHRP Recommended Provisions for Seismic Regulations for New Buildings and other Structures " Building Seismic Safety Council, Washington, D.C., 1997.
- [10] Balendra, T., Lam, N.T., Wilson, J.L., Kong, K.H.: " Analysis of Long-Distance Earthquake Tremors and Base Shear Demand for Buildings in Singapore " Journal of Engineering Structures, Vol. 24, pp. 99-108, 2002.
- [11] Kaushik, H.B., Rai, D.C., Jain, S.K.: " Code Approaches to Seismic Design of Masonry-Infilled Reinforced Concrete Frames: A State-of-the-Art Review " Journal of Earthquake Spectra, Vol. 22, pp. 961-983, 2006.
- [12] Saudi Building Code Requirements, 301, Structural - Loading and Forces, 2007.
- [13] Saudi Building Code Requirements, 304, Structural - Concrete Structures, 2007.
- [14] Smith, B.S.: " Lateral Stiffness of Infilled Frames" Journal of Structural Division, Vol. 88, No. 6, pp. 183-199, 1962.
- [15] Mainstone, R. J.: " Supplementary Note on the Stiffness and Strength of Infilled Frames." Building Research Station, Garston, Watford, 1974.
- [16] Al-Chaar, G., Issa, M.: " Behavior of Masonry-Infilled Nonductile Reinforced Concrete Frames" Journal of Structural Engineering, Vol. 128, No. 8, pp. 1055-1063, 2002.
- [17] Klingener, R. E., Bertero, V. V.: " Earthquake Resistance of Infilled Frames " Journal of Structural Division, Vol. 104, No. 6, pp. 973-989, 1978.
- [18] Kose, M.M.: " Parameters Affecting the Fundamental Period of RC buildings with Infill Walls" Journal of Engineering Structures, Vol. 31, pp. 93-102, 2009.
- [19] Abo El-Wafa, W.M.: " Effect of Masonry Infill Walls on the Natural Period of Reinforced Concrete Buildings" Journal of Engineering Science, Assiut University, Vol. 37, No.1, 2009.
- [20] Sobaih, M., Abdin, M.M.: " Seismic Analysis of Infilled Reinforced Concrete Frames " Computer & Structures, Vol. 30, No. 3, pp. 457 - 464, 1988.
- [21] Abo El-Wafa, W.M.: " Nonlinear Lateral Response of Masonry Infilled RC Buildings with Variable Parameters" Journal of Engineering Science, Faculty of Engineering, Assiut University, Vol. 37, No. 3, pp. 521-541, May (2009).
- [22] Dolsek, M., Fajfar, P.: " The Effect of Masonry Infills on the Seismic Response of a Four Soft Storey Reinforced Concrete Frame - a probabilistic assessment " Journal of Engineering Structures, Vol. 30, pp. 3186 -3192, 2008.
- [23] Bell, D.K., Davidson, B.J.: " Earthquake Assessment of R/C Structures with Masonry Infill Panels " NZSEE 2001 Conference, Paper No.4.02.01, 2001.

[24] " ETABS, Nonlinear version 9 Beta, Extended 3-D Analysis of Building Systems" Computers and Structures, Inc., Berkeley, U.S.A., 2005.

IJSER